

REVIEWED

By Gary Yam (gary@spinmaster.com) at 10:51 am, Apr 27, 2016

# MECCANO™

MAKER SYSTEM

## MICRONOID™ SOCKET

16401



 **8+**

Instructions  
Notice de montage  
Instrucciones de construcción  
Bauanleitung

Bouwinstructie  
Istruzioni  
Instruções  
Инструкции





### CONSTRUCTION TIPS / ASTUCES DE CONSTRUCTION

TIPS DE CONSTRUCCIÓN / TIPPS ZUM BAUEN  
MONTAGETIPS / SUGGERIMENTI PER COSTRUIRE  
DICAS DE MONTAGEM / РЕКОМЕНДАЦИИ ПО СБОРКЕ

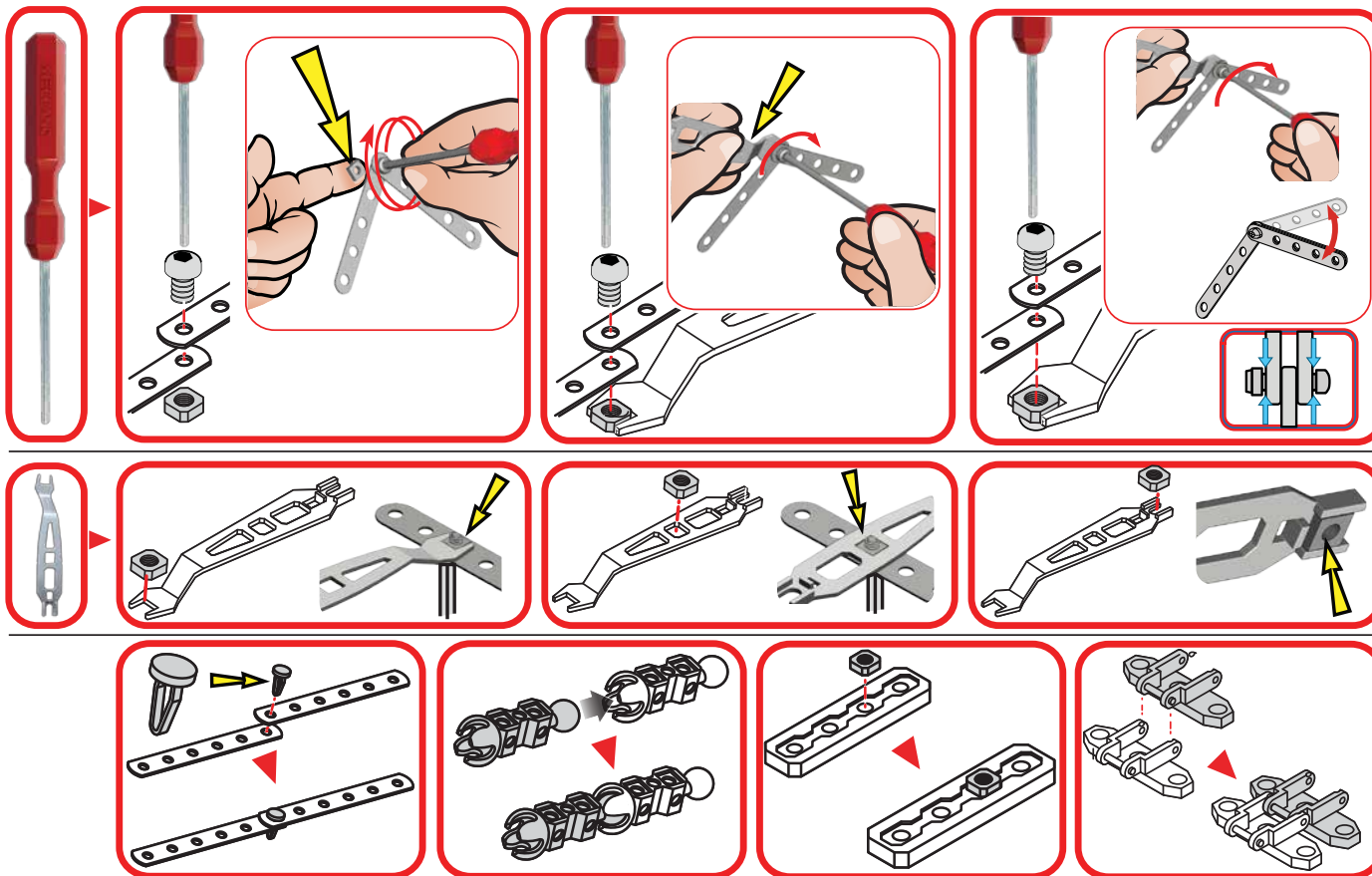

# TABLE OF CONTENTS / SOMMAIRE

## ÍNDICE / INHALTSVERZEICHNIS / INHOUD / INDICE / ÍNDICE / СОДЕРЖАНИЕ



|  |
|--|
| <b>EN.</b> Content: 123 parts, 1 Head Micro Module, 2 hand tools, 1 instruction manual                       |
| <b>FR.</b> Contenu: 123 pièces, 1 micro module motorisé, 2 outils manuels, 1 mode d'emploi                   |
| <b>ES.</b> Contenido: 123 piezas, 1 micro módulo motorizado, 2 herramientas de mano, 1 guía de instrucciones |
| <b>DE.</b> Inhalt: 123 Teile, 1 Micro-Motor-Modul, 2 Handwerkzeuge, 1 Bedienungsanleitung                    |
| <b>NL.</b> Inhoud: 123 onderdelen, 1 gemotoriseerde micro-module, 2 handgereedschappen, 1 gebruiksaanwijzing |
| <b>IT.</b> Contenuto: 123 pezzi, 1 micro modulo motorizzato, 2 attrezzi, 1 guida per l'uso                   |
| <b>PT.</b> Conteúdo: 123 peças, 1 micro módulo motorizado, 2 ferramentas manuais, 1 manual de instruções     |
| <b>RU.</b> В комплекте: 123 детали, 1 <b>двигающийся</b> микромодуль, 2 ручных инструмента, 1 инструкция     |

**FCC Statement:** This device complies with Part 15 of the FCC rules. Operation is subject to the following two conditions:

(1) This device may not cause harmful interference, and (2) This device must accept any interference received, including interference that may cause undesired operation.

This equipment has been tested and found to comply with the limits for Class B digital devices pursuant to Part 15 of the FCC rules. These limits are designed to provide reasonable protection against harmful interference to radio communications. This equipment generates, uses and can radiate radio frequency energy and, if not installed and used in accordance with the instruction, may cause harmful interference to radio communication. However, there is no guarantee that interference will not occur in a particular installation. If this toy does cause interference to radio or television reception (you can check this by turning the toy off and on while listening for the interference), one or more of the following measures may be useful:

- Reorient or relocate the receiving antenna.
- Increase the separation between the toy and the radio or the TV.
- Consult the dealer or an experienced TV-radio technician for help.

**NOTE:** Changes, adjustments or modifications to this unit, including but not limited to, replacement of any transmitter component (crystal, semiconductor, etc) could result in a violation of FCC rules under part 15 and/or 95 and must be expressly approved by Spin Master Ltd. or they could void the user's authority to operate the equipment.

**Déclaration FCC :** Cet appareil est conforme à l'article 15 de la réglementation de la FCC. Son utilisation est soumise aux deux conditions suivantes :

(1) Cet appareil ne doit pas causer d'interférences nuisibles, et (2) Cet appareil doit tolérer toutes les interférences reçues, y compris celles pouvant entraîner un fonctionnement indésirable.

Cet équipement a été testé et jugé conforme aux limites de la classe B pour les équipements numériques en vertu de l'article 15 de la réglementation de la FCC. Ces limites ont été instaurées pour assurer une protection raisonnable contre toute interférence nuisible avec les communications radios. Cet équipement génère, utilise et peut émettre de l'énergie de fréquence radio. S'il n'est pas installé et utilisé selon le mode d'emploi, il peut causer des interférences nuisibles aux communications radios. Cependant, selon l'installation, des interférences peuvent être constatées. Si ce jouet cause des interférences à la réception radio ou télévisée (ce qui est vérifiable en l'éteignant, puis en le rallumant tout en écoutant s'il y a des interférences), suivre une ou plusieurs des recommandations suivantes :

- Réorienter ou déplacer l'antenne réceptrice.
- Augmenter la distance entre le jouet et la radio ou la télévision.
- Consulter le revendeur ou demander l'aide d'un technicien radio/TV expérimenté.

**REMARQUE :** tout changement, réglage ou modification de cet appareil, incluant mais ne se limitant pas au remplacement de tout composant du transmetteur (cristal, semi-conducteur, etc.), pourrait constituer une violation de l'article 15 et/ou 95 de la réglementation de la FCC, et doit être expressément approuvé par Spin Master Ltd., sous peine d'entraîner l'annulation du droit de l'utilisateur d'exploiter l'équipement.

**Declaración de la FCC:** Este aparato cumple con el artículo 15 de las normas de la FCC.

**El funcionamiento está sujeto a las dos siguientes condiciones:** (1) Este aparato no debe causar interferencias perjudiciales, y (2) Este aparato debe aceptar cualquier interferencia recibida, incluidas las que podrían causar un funcionamiento no deseado.

Este equipo se sometió a las pruebas debidas y se comprobó que cumple con los requisitos específicos para aparatos digitales de clase B en conformidad con el artículo 15 de las normas de la FCC. Estos requisitos están diseñados para proporcionar protección razonable contra interferencias perjudiciales en las comunicaciones por radio. Este juguete genera, utiliza y puede emitir energía de radiofrecuencia. Si no se instala y se utiliza de acuerdo con la guía de instrucciones, puede causar interferencias en las comunicaciones por radio. Sin embargo, en función de la instalación, pueden ocurrir interferencias. Si este juguete ocasiona interferencias perjudiciales en la recepción radio o televisiva (lo cual se puede comprobar encendiendo y apagando el juguete mientras se escucha la interferencia), seguir una o varias de las siguientes recomendaciones:

- Volver a orientar o ubicar la antena receptora.
- Aumentar la distancia entre el juguete y la radio o el televisor.
- Consultar al distribuidor o a un técnico especializado en radio y televisión.

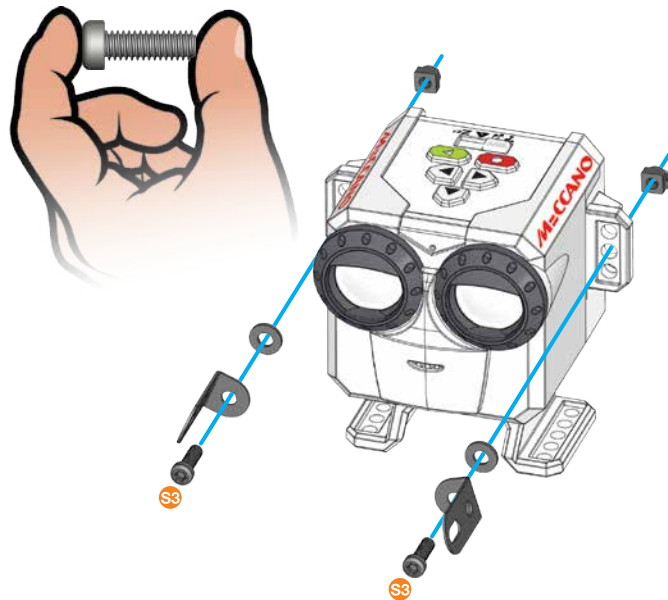
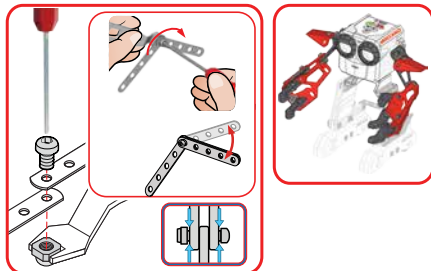
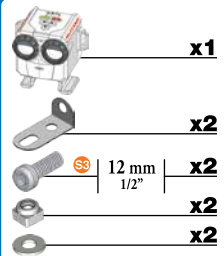
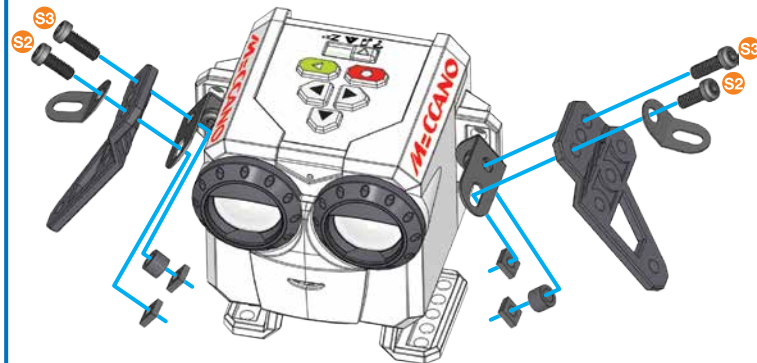
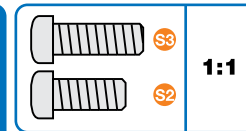
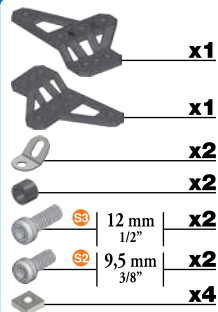

**NOTA:** Los cambios, ajustes o modificaciones realizados sobre este aparato, incluidos pero no limitados al cambio de cualquier componente del transmisor (emisor de cristal, semiconductor, etc.) podrían constituir una violación del artículo 15 y/o 95 de las normas de la FCC y deberían ser expresamente aprobados por Spin Master Ltd., de lo contrario quedaría inválida la autoridad del usuario para usar el equipo.

CAN ICES-3(B)/NMB-3(B)

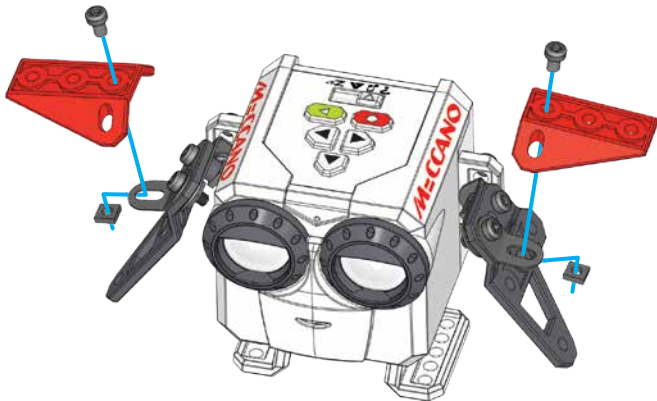
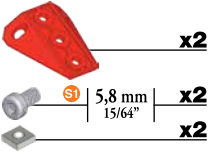
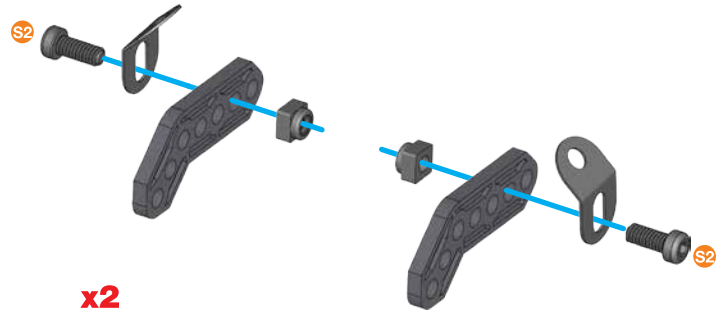
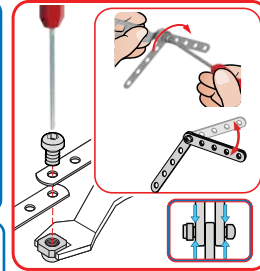
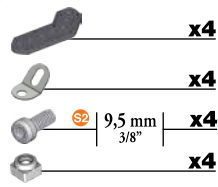
**1****2**

**3****4****x2****5**



**5** (4)+

|  |                              |
|--|------------------------------|
|     | <b>x2</b>                    |
|  S1 | 5,8 mm   <b>x4</b><br>15/64" |
|     | <b>x4</b>                    |

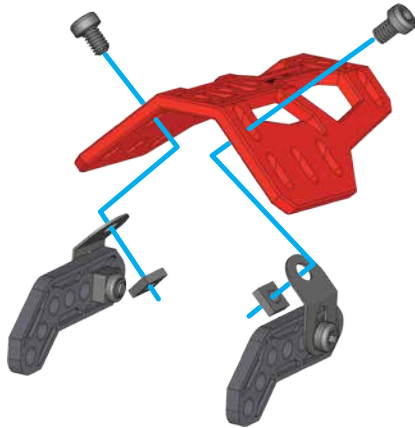
|   |    |            |
|---|----|------------|
|  | S1 | <b>1:1</b> |
|---|----|------------|



**6**

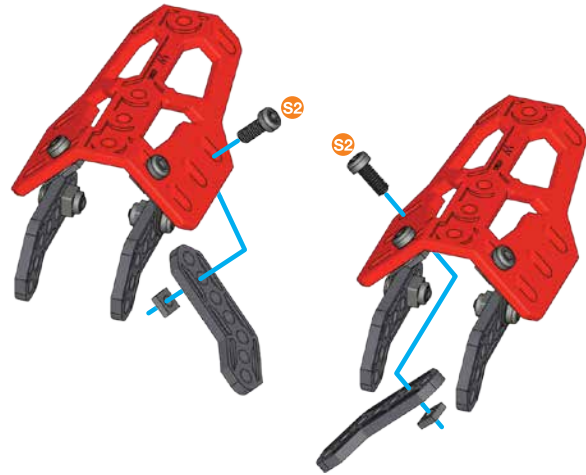

|   |                            |
|---|----------------------------|
|     | <b>x2</b>                  |
|  S2 | 9,5 mm   <b>x2</b><br>3/8" |
|     | <b>x2</b>                  |

|  |    |            |
|--|----|------------|
|  | S2 | <b>1:1</b> |
|--|----|------------|



7

③ + ⑥ +

-  S3 | 12 mm | **x2**
-  | **x2**
-  | **x2**

-  S3 | **1:1**

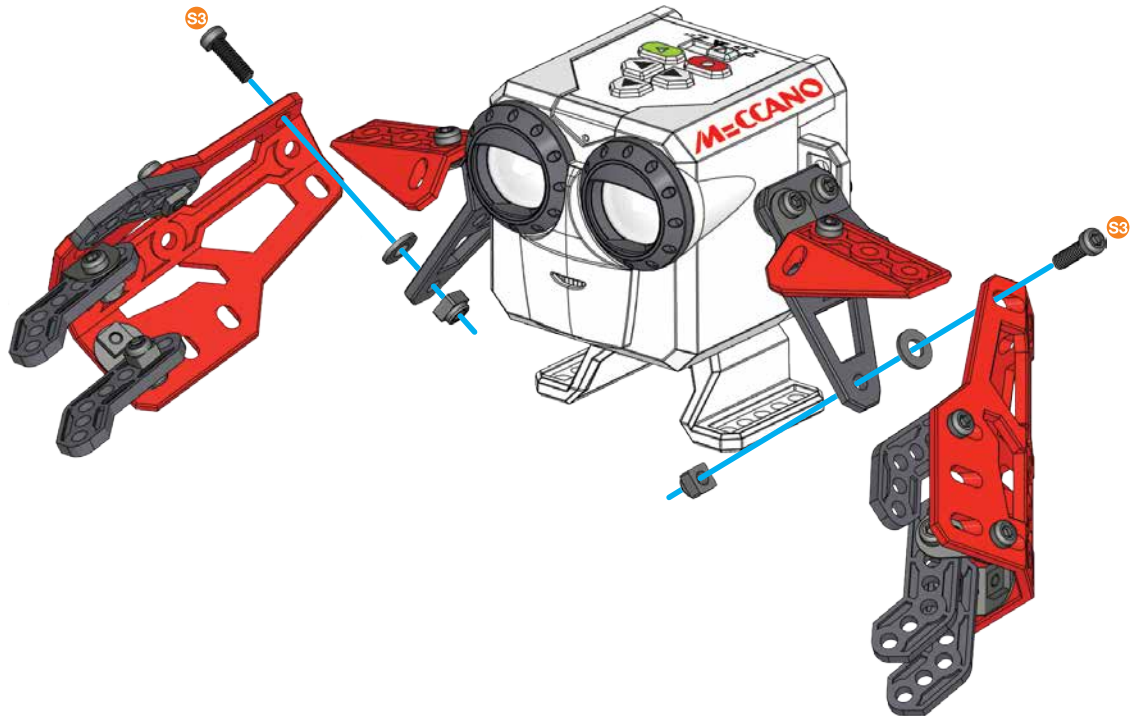
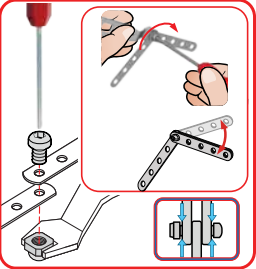



8

 x1

 12 mm | x1

 1/2" | x1

 1:1

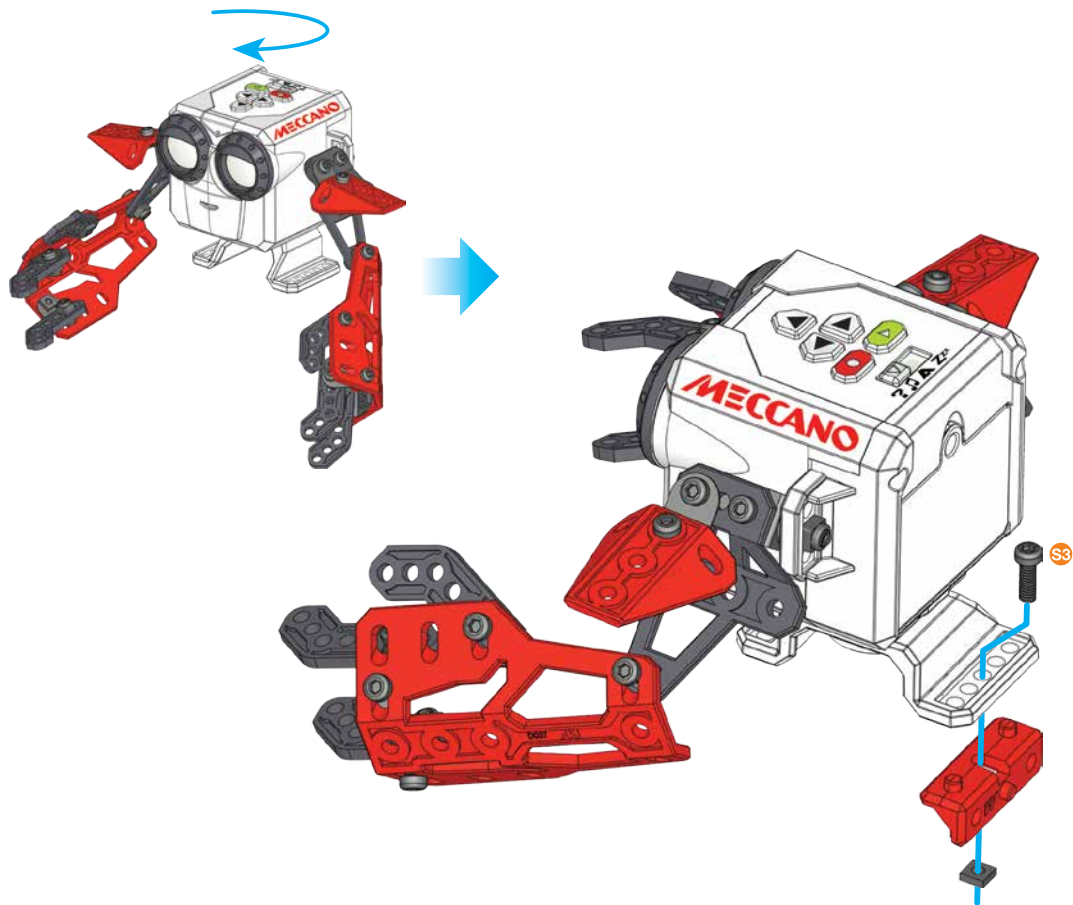



9

 **x1**

 12 mm | **x1**  
1/2"

 **x1**

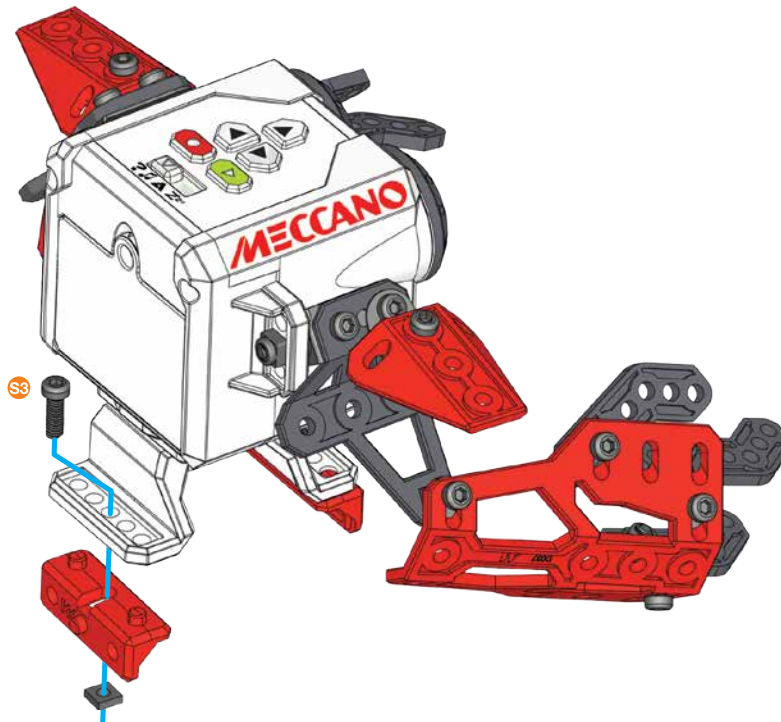
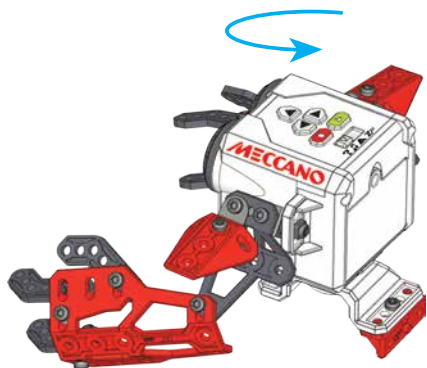

 **1:1**

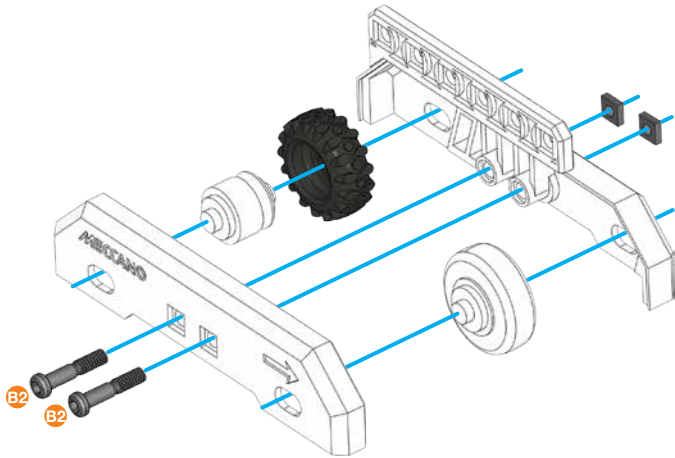
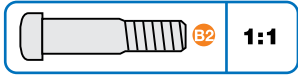
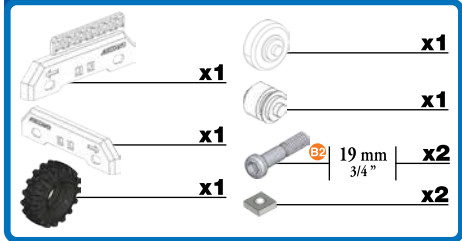
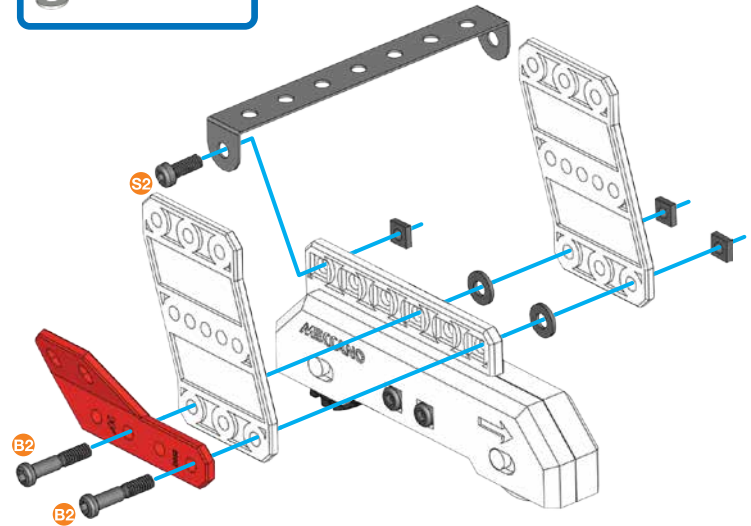
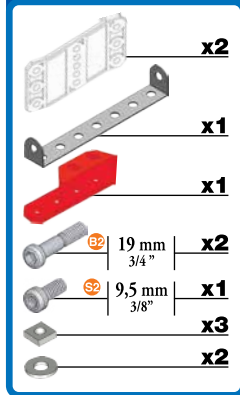

**10****11**

# 12





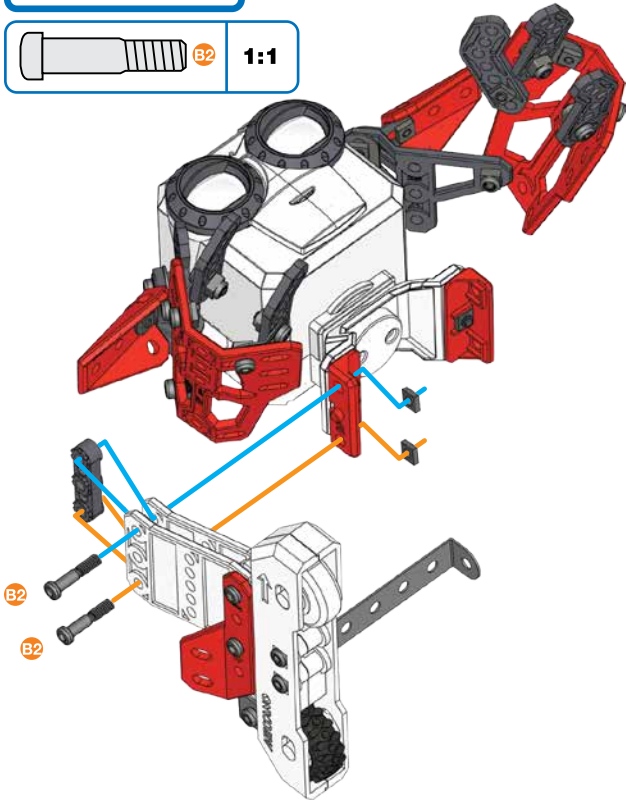
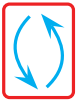

9 + 11 +

-  **x1**
-  19 mm | 3/4" **x2**
-  **x2**

-  **B2** **1:1**





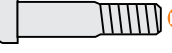

# 13

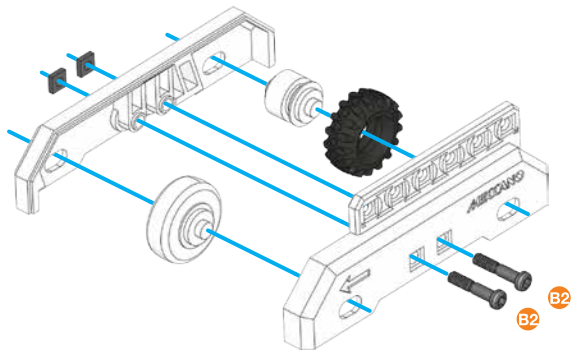
-  **x1**
-  **x1**
-  **x1**
-  **x1**
-  **x1**
-  19 mm | 3/4" **x2**
-  **x2**

-  **B2** **1:1**



14



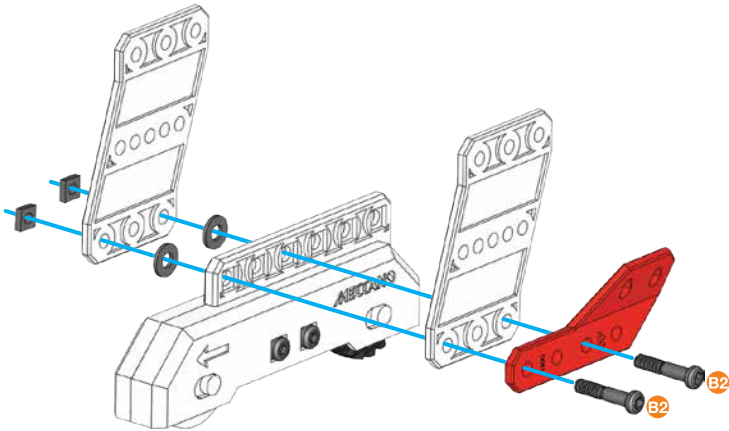

-  **x2**
-  **x1**
-  19 mm **x2**  
3/4"
-  **x2**
-  **x2**

-  **B2** **1:1**



15

12 + 14 +

-  **x1**
-  19 mm **x2**  
3/4"
-  9,5 mm **x1**  
3/8"
-  **x3**

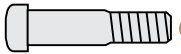
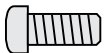
-  **B2**
-  **S2**
- 1:1**

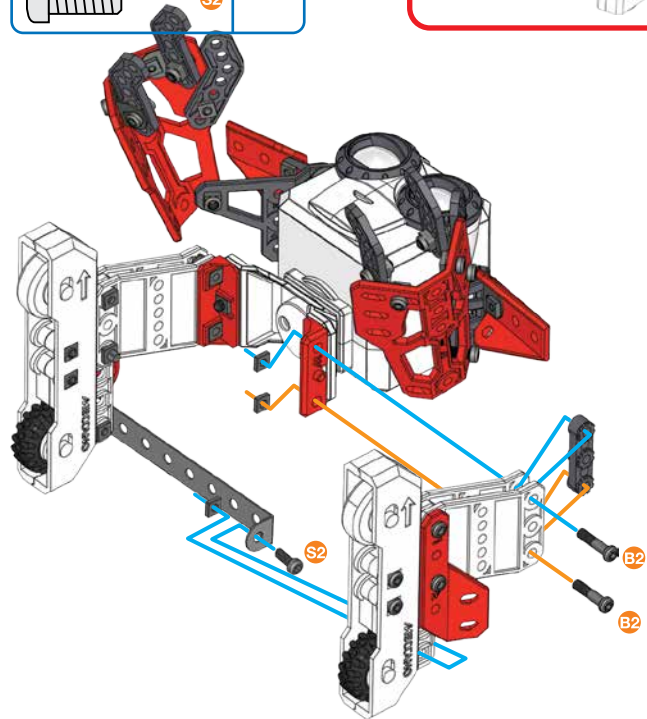
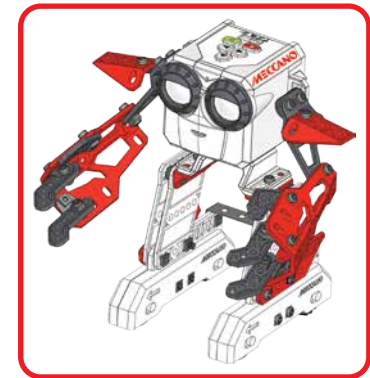



**M913 x1**



**D037 x2**



**M234 x2**



**D051 x1**



**D052 x1**



**M001 x2**



**A382 x2**



**M249 x2**



**M246 x2**

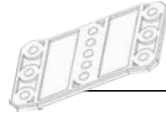

**M231 x4**



**A348 x1**

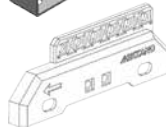

**M248 x2**

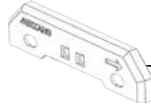

**M247 x2**



**D089 x1**



**D090 x1**



**A260 (0260) x6**



**A420 (0260G) x2**



**A512 (0812D) x2**



**A712 (0077) x6**



**B2**

19 mm  
3/4"

**A447 (0147F) x12**



**S3**

12 mm  
1/2"

**A411 (0111A) x8**



**S2**

9,5 mm  
3/8"

**A511 (0111C) x10**



**S1**

5,8 mm  
15/64"

**A637 (0037B) x6**



**A337 (0037A) x28**



**A737 (0037H) x8**



**A138 (0038) x8**



**A338 x2**



**C995 x1**



**C993 x1**

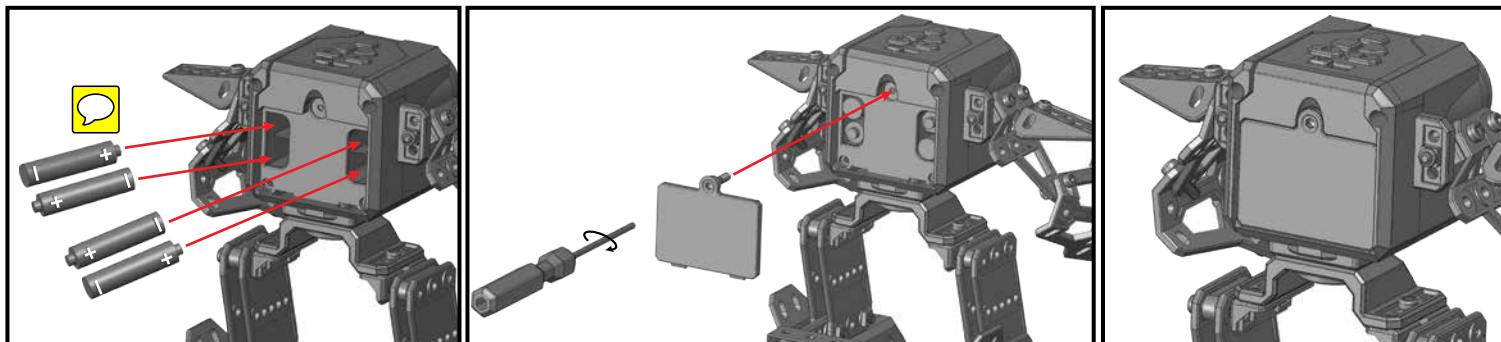

**EN** 1. Open the battery door with a screwdriver.

2. If used batteries are present, remove these batteries from the unit by pulling up on one end of each battery. DO NOT remove or install batteries using sharp or metal tools.
3. Install new batteries as shown in the polarity diagram (+/-) inside the battery compartment.
4. Replace battery door securely.
5. Check your local laws and regulations for correct recycling and/or battery disposal.

**FR** 1. Ouvrir le compartiment des piles à l'aide d'un tournevis.

2. S'il contient des piles usagées, les retirer en les soulevant par l'une des extrémités. NE PAS utiliser d'objet coupant ou métallique pour retirer ou insérer les piles.
3. Insérer les nouvelles piles en respectant le schéma de polarité (+/-) dans le compartiment des piles.
4. Bien refermer le compartiment des piles.
5. Recycler ou jeter les piles usagées conformément à la législation locale.

**ES** 1. Abra la tapa del compartimento de las pilas con un destornillador.

2. Si las pilas están gastadas, tire hacia arriba de uno de sus extremos para extraerlas. NO utilice herramientas metálicas o puntiagudas para instalar o extraer las pilas.
3. Instale las pilas nuevas como se muestra en el esquema de polaridad (+/-) dentro del compartimento de las pilas.
4. Vuelva a colocar la tapa del compartimento de las pilas.
5. Consulte la normativa local relativa al reciclaje y desecho de las pilas.

**DE** 1. Batteriefachabdeckung mit einem Schraubendreher öffnen.

2. Wenn sich gebrauchte Batterien darin befinden, diese einzeln herausziehen. Batterien NICHT mit scharfen oder metallenen Gegenständen entfernen oder einlegen.
3. Neue Batterien unter Beachtung des Polaritätsdiagramms (+/-) in das Batteriefach einlegen.
4. Batteriefachabdeckung wieder anbringen.
5. Örtliche Gesetz und Bestimmungen für das Recycling bzw. die Entsorgung von Altbatterien beachten.

**NL** 1. Open het batterijdeksel met een schroevendraaier.

2. Verwijder eventueel gebruikte aanwezige batterijen uit de unit door één kant van elke batterij omhoog te trekken. Verwijder of plaats batterijen NIET met behulp van scherpe of metalen voorwerpen.
3. Plaats de nieuwe batterijen zoals weergegeven op het polariteitsdiagram (+/-) aan de binnenkant van het batterijvak.
4. Sluit het vak af met het batterijdeksel.
5. Lees de plaatselijke voorschriften en regelgeving om de batterijen op de juiste wijze te recyclen of af te voeren.

**IT** 1. Aprire lo scomparto pile con un cacciavite.

2. Se sono presenti pile usate, rimuoverle dall'unità sollevandole da un'estremità. NON usare oggetti metallici o appuntiti per rimuovere o installare le pile.
3. Inserire le nuove pile seguendo il diagramma della polarità (+/-) all'interno dello scomparto pile.
4. Riporre saldamente lo sportello dello scomparto pile.
5. Eliminare e/o riciclare le pile secondo quanto previsto dalle normative locali vigenti.

**PT** 1. Abra a tampa do compartimento de pilhas com uma chave de fenda.

2. Se houver pilhas usadas, retire-as da unidade individualmente, puxando pela extremidade de cada uma. NÃO retire ou coloque pilhas com qualquer acessório pontiagudo ou metálico.
3. Instale pilhas novas seguindo o diagrama de polaridade (+/-) dentro do compartimento de pilhas.
4. Coloque de novo a porta do compartimento com cuidado.
5. Consulte as leis, as normas e os regulamentos locais de reciclagem e/ou descarte de pilhas e baterias.

**RU** 1. Откройте крышку отсека элементов питания с помощью отвертки.

2. Извлеките старые или истощенные элементы питания из отсека (при их наличии), подняв каждый элемент питания за край. Запрещается извлекать или **устанавливать** батареи с помощью острых или металлических предметов.
3. Установите новые элементы питания внутри отсека, соблюдая **полярность** (+/-).
4. Надежно закройте крышку отсека.
5. Ознакомьтесь с законами и нормативами вашей страны, установленными в отношении правил переработки и/или утилизации элементов питания.



## MODE FUNCTIONS

### 8-BALL MODE

This mode allows your MicroNoid to answer YES or NO questions. Ask your MicroNoid a YES or NO question and he will give you an honest answer (whether you like it or not). Be sure to speak loudly and clearly in his direction.

### OFF POSITION

This will power down your MicroNoid. Make sure you do this after you've finished playing with him so that you don't drain his batteries.

? 🎵 A ZZZ

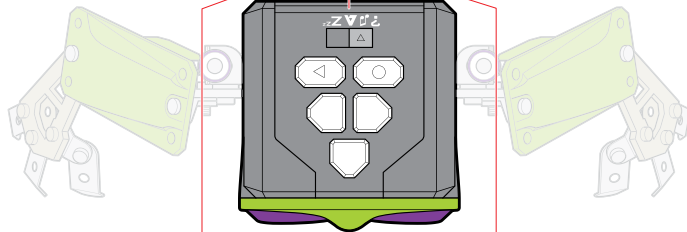

### DANCE MODE

MicroNoid loves to **Dance!** Play music close to your MicroNoid and he will dance to the beat. If you leave him in this mode too long, he might just start dancing to his own tune.

### AUTONOMOUS MODE

MicroNoid has a mind of his own. He may giggle, fart, babble, dance, or sing in this mode. If there's another MicroNoid nearby, they may start interacting with each other or dancing to a synchronized routine.

## BUTTON FUNCTIONS

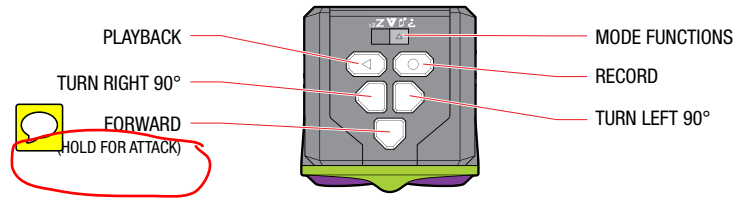

### PUSH BUTTON PROGRAMMING

This allows you to use the arrow buttons to build your own custom walking and turning sequence. If you speak to him in this mode, he will record your voice, and repeat it in his robot voice.

#### 1. PRESS RECORD

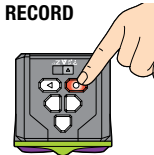

#### 2. PUSH ARROW SEQUENCE

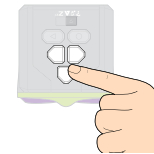

#### 3. PRESS FOR PLAYBACK

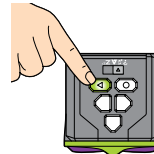

### LIM PROGRAMMING

(LEARNED INTELLIGENT MOTION)

This allows you to rotate the head to record your own custom walking and turning sequence. If you speak to him in this mode, he will record your voice, and repeat it in his robot voice.

#### 1. PRESS RECORD

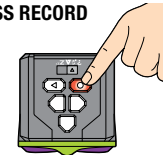

#### 2. TWIST HEAD

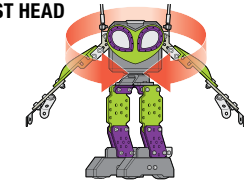

#### 3. PRESS FOR PLAYBACK

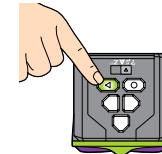



## FONCTIONS DES MODES

### MODE OUI/NON

Ce mode permet à ton MicroNoid de répondre par OUI ou NON à tes questions. Pose à ton MicroNoid une question. Il te répondra franchement par OUI ou par NON (que ça te plaise ou non). **Parler** fort et distinctement dans sa direction.

### POSITION ARRÊT

Ton MicroNoid sera mis hors tension. Une fois que tu as fini de jouer avec lui, veille à bien le mettre hors tension pour ne pas user ses piles.

### MODE DANSE

Le MicroNoid adore danser ! Joue de la musique près de ton MicroNoid pour qu'il danse dessus. Si tu le laisses danser dans ce mode trop longtemps, il pourrait bien commencer à danser sur un air bien à lui.

### MODE AUTONOME

Le MicroNoid est du genre indépendant. Dans ce mode, il peut très bien rigoler, faire un prout, babiller ou chanter. Si un autre MicroNoid se trouve à proximité, ils peuvent se mettre à communiquer ou à effectuer une choré de danse synchronisée.

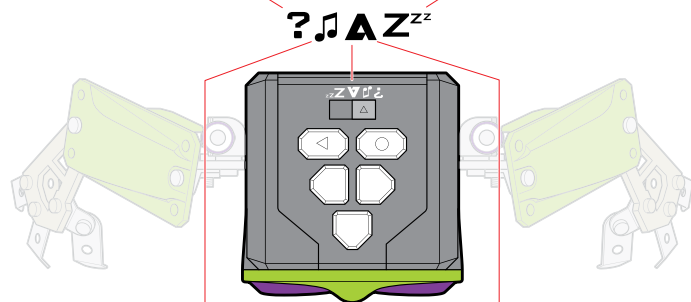

## FONCTIONS BOUTONS

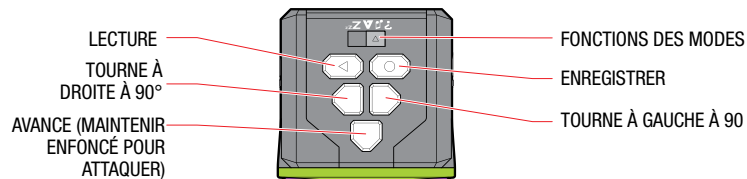

### PROGRAMMATION BOUTONS

Cela te permet d'utiliser les flèches pour créer une séquence de déplacements personnalisée. Si tu lui parles dans ce mode, il enregistre ta voix et la répète avec sa voix de robot.

#### 1. APPUIE SUR ENREGISTRER



#### 2. SÉQUENCE FLÈCHES



#### 3. APPUIE POUR LIRE

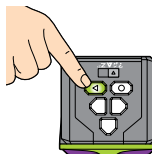

### PROGRAMMATION LIM (LEARNED INTELLIGENT MOTION)

Cela te permet de faire pivoter la tête pour créer une séquence de déplacements personnalisée. Si tu lui parles dans ce mode, il enregistre ta voix et la répète avec sa voix de robot.

#### 1. APPUIE SUR ENREGISTRER

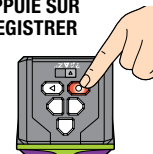

#### 2. TOURNER LA TÊTE

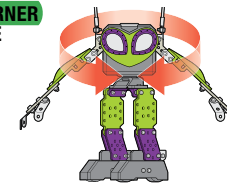

#### 3. APPUIE POUR LIRE

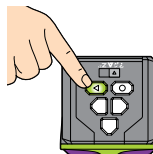

## FUNCIONES DE CADA MODO

### 8. MODO DE PREGUNTAS

En este modo MicroNoid puede contestar a preguntas con SÍ o NO. Pregúntale a MicroNoid algo para que te responda con sinceridad (te guste o no la respuesta). Asegúrate de hablar alto y claro.

### POSICIÓN DE APAGADO

Este modo apagará tu MicroNoid. Asegúrate de hacerlo después de haber terminado de jugar con él para que no se gasten las pilas.

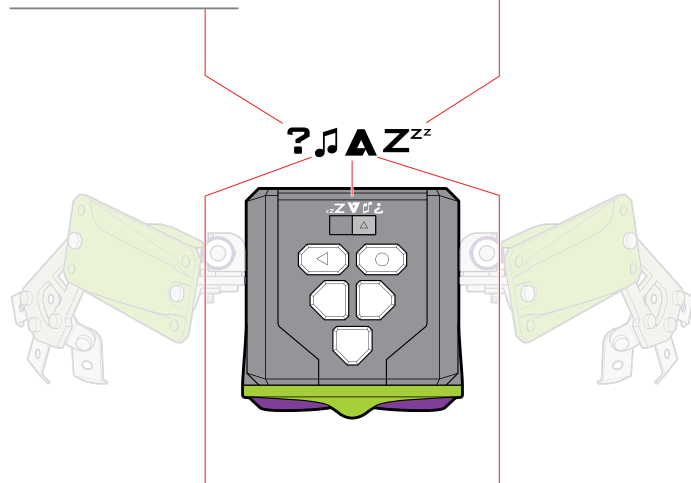

### MODO BAILA

¡A MicroNoid le encanta bailar! Pon música y bailará al ritmo de ella. Si lo dejas en este modo durante demasiado tiempo, hasta puede empezar a bailar a su ritmo.

### MODO AUTÓNOMO

MicroNoid actúa por sí mismo. Mientras está en este modo se ríe, se tira pedos, balbucea, baila o canta. Además, si hay otro MicroNoid cerca, empezarán a interactuar entre ellos o a bailar una rutina sincronizada.

## FUNCIONES DE LOS BOTONES

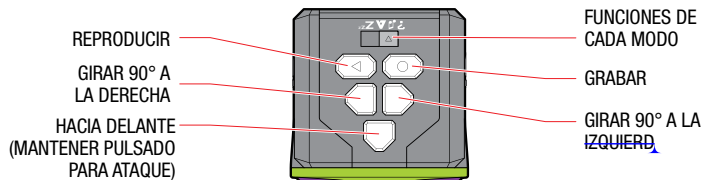

### PROGRAMACIÓN PULSANDO EL BOTÓN

Utiliza los botones de flecha para crear tu propia secuencia de movimiento para andar y para girar. Si le hablas en este modo, grabará tu voz y repetirá la misma frase con su voz de robot.

#### 1. PULSAR PARA GRABAR

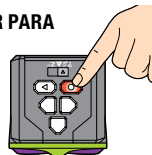

#### 2. PULSAR SECUENCIA DE FLECHAS

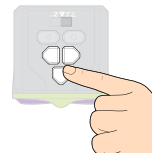

#### 3. PULSAR PARA REPRODUCCIÓN

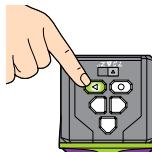

### PROGRAMACIÓN M.I.A (MOVIMIENTO INTELIGENTE APRENDIDO)

Permite hacerle girar la cabeza para grabar tu propia secuencia de movimiento para andar y para girar. Si le hablas en este modo, grabará tu voz y repetirá la misma frase con su voz de robot.

#### 1. PULSAR PARA GRABAR



#### 2. GIRAR CABEZA

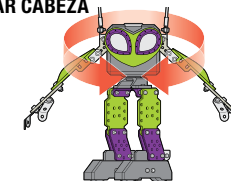

#### 3. PULSAR PARA REPRODUCCIÓN

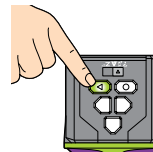



## FUNKTIONEN DER VERSCHIEDENEN MODI

### ORAKEL-MODUS

In diesem Modus beantwortet dein MicroNoid JA- oder Nein-Fragen. Stell deinem MicroNoid eine JA- oder Nein-Frage und er wird dir ehrlich antworten (ob dir die Antwort gefällt oder nicht). Achte darauf, dass du laut und deutlich in seine Richtung sprichst.

### POSITION AUS

So schaltest du deinen MicroNoid aus. Achte darauf, ihn nach dem Spielen immer auszuschalten, damit seine Batterien länger halten.

? 🎵 A ZZZ

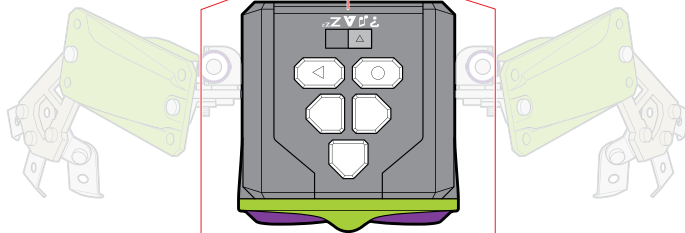

### TANZMODUS

MicroNoid tanzt für sein Leben gern! Wenn du in der unmittelbaren Nähe deines MicroNoid Musik abspielst, wird er zum Rhythmus tanzen. Wenn du ihn zu lange in diesem Modus belässt, tanzt er, wie es ihm gefällt.

### ZUFALLSMODUS

MicroNoid hat seinen eigenen Kopf. In diesem Modus wird er kichern, pupsen, tanzen oder singen. Wenn sich ein anderer MicroNoid in der Nähe befindet, können die beiden miteinander interagieren oder gemeinsam einen Tanz aufführen.

## TASTEN-FUNKTIONEN

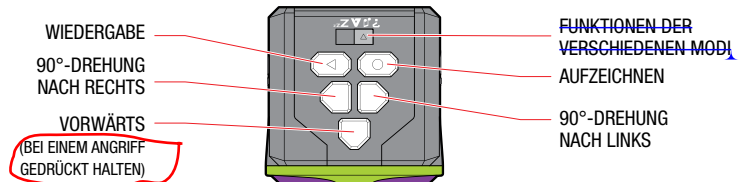

### TASTEN-PROGRAMMIERUNG

In diesem Modus kannst du mit den Pfeiltasten eine eigene Bewegungsabfolge (Gehen und Drehen) erstellen. Wenn du in diesem Modus mit deinem MicroNoid sprichst, nimmt er deine Stimme auf und wiederholt das Gesagte mit seiner Roboterstimme.

#### 1. AUFZEICHNEN DRÜCKEN

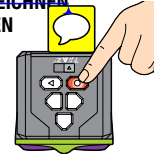

#### 2. PFEILTASTEN-ABFOLGE EINGEBEN

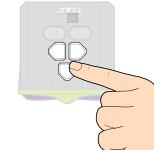

#### 3. ZUR WIEDERGABE DRÜCKEN

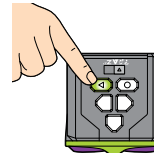

### LIM-PROGRAMMIERUNG (LEARNED INTELLIGENT MOTION)

In diesem Modus kannst du über Drehen des Kopfes eine eigene Bewegungsabfolge (Gehen und Drehen) erstellen. Wenn du in diesem Modus mit deinem MicroNoid sprichst, nimmt er deine Stimme auf und wiederholt das Gesagte mit seiner Roboterstimme.

#### 1. AUFZEICHNEN DRÜCKEN

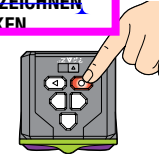

#### 2. KOPF DREHEN

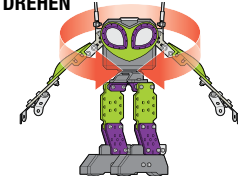

#### 3. ZUR WIEDERGABE DRÜCKEN

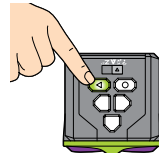

## MODUSFUNCTIES

### 8-BALLMODUS



In deze modus kan je MicroNoid ja- en **neevragen** stellen. Stel een **ja-of-neevraag** aan je MicroNoid en hij zal je een eerlijk antwoord geven (of je dat nu leuk vindt of niet). Zorg dat je luid en duidelijk in zijn richting praat.

### UIT

Hiermee wordt je MicroNoid uitgeschakeld. Zorg ervoor dat je dit doet als je klaar bent met spelen, zodat de batterijen niet leeglopen.

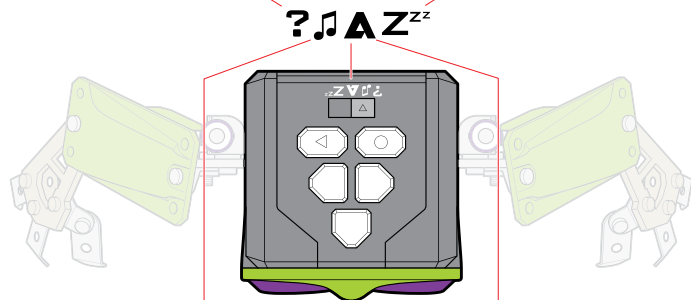

### DANSMODUS

MicroNoid is dol op dansen! Speel dicht bij je MicroNoid muziek af en hij zal dansen op de beat. Als je hem te lang in deze modus laat, kan hij zelf beginnen te dansen.

### ZELFSTANDIGE MODUS

MicroNoid heeft een eigen willetje. Hij kan lachen en scheten laten, babbelen, dansen en zingen in deze modus. Als er een andere MicroNoid in de buurt is, kunnen zij met elkaar communiceren of synchroon gaan dansen.

## KNOPFUNCTIES

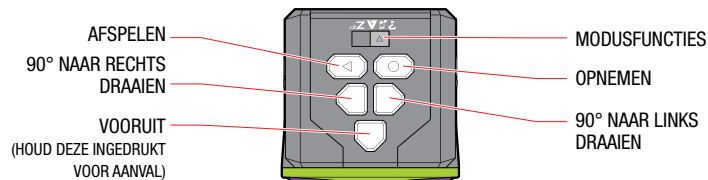

### PROGRAMMEERKNOP

Hiermee kun je met de pijlknoppen zelf een wandel- en draairoutine maken. Als je tegen hem praat in deze modus, zal hij je stem opnemen en alles herhalen in een robotstem.

#### 1. DRUK OP OPNEMEN

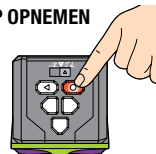

#### 2. DRUK OP EEN REEKS PIJLEN

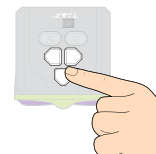

#### 3. DRUK OM AF TE SPELEN

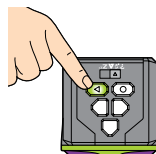

### LIM-PROGRAMMEREN

(LEARNED INTELLIGENT **MOTION**)

Hiermee kun je zijn hoofd draaien om je eigen wandel- en draairoutine vast te leggen. Als je tegen hem praat in deze modus, zal hij je stem opnemen en alles herhalen in een robotstem.

#### 1. DRUK OP OPNEMEN

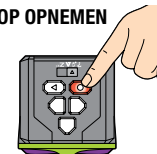

#### 2. HOOFD DRAAIEN

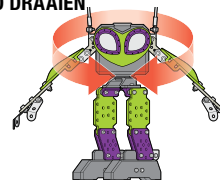

#### 3. DRUK OM AF TE SPELEN

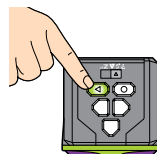

## FUNZIONI DELLE MODALITÀ

### MODALITÀ INDOVINO

Questa modalità consente al tuo MicroNoid di rispondere a domande che richiedono un SÌ o un NO. Fai una domanda che richiede un SÌ o un NO al tuo MicroNoid e ti risponderà in modo sincero (che ti piaccia o no). Assicurati di parlare nella sua direzione ad alta voce e in modo chiaro.

### POSIZIONE OFF

In questa modalità il tuo MicroNoid si spegne. Assicurati di spegnerlo quando finisci di giocare in modo da non far scaricare le pile.

? 🎵 A ZZZ

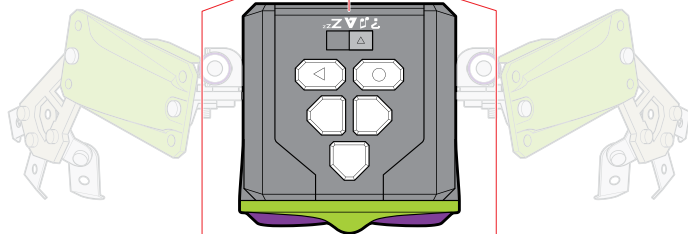

### MODALITÀ BALLO

MicroNoid ama ballare! Riproduci della musica vicino al tuo MicroNoid e inizierà a ballare seguendo il ritmo. Se lasci attiva questa modalità per un periodo di tempo prolungato, potrebbe iniziare a ballare un suo motivetto.

### MODALITÀ AUTONOMA

MicroNoid pensa con la sua testa. In questa modalità può ridere, fare le puzette, fargliare, ballare o cantare. Se nelle vicinanze c'è un altro MicroNoid, i due potrebbero iniziare a interagire tra loro oppure ballare una sequenza di passi sincronizzata.

## FUNZIONI DEI PULSANTI

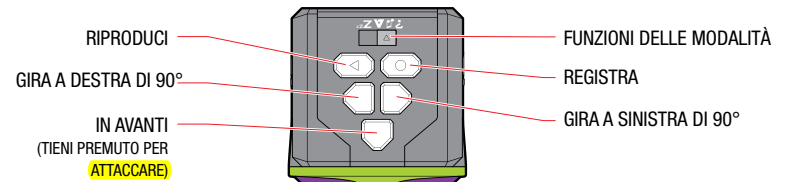

### PROGRAMMAZIONE DEI PULSANTI

È possibile utilizzare i pulsanti freccia per creare la tua sequenza personalizzata di passi. Se gli parli durante questa modalità, registrerà la tua voce e la ripeterà con la sua voce robotica.

#### 1. PREMI REGISTRA



#### 2. SELEZIONA SEQUENZA FRECCIE

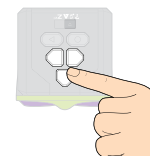

#### 3. PREMI PER RIPRODURRE

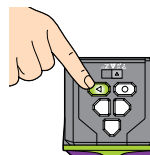

### APPRENDIMENTO INTELLIGENTE DEI MOVIMENTI PROGRAMMAZIONE L.I.M.

È possibile far ruotare la testa per registrare la tua sequenza personalizzata di passi. Se gli parli durante questa modalità, registrerà la tua voce e la ripeterà con la sua voce robotica.

#### 1. PREMI REGISTRA



#### 2. RUOTA TESTA

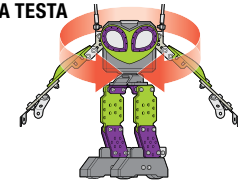

#### 3. PREMI PER RIPRODURRE

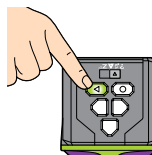

## FUNÇÕES DE CADA MODO

### MODO BOLA 8

Esse modo permite que seu MicroNoid responda uma pergunta que exija uma resposta SIM ou NÃO. Faça uma pergunta para seu MicroNoid que exija uma resposta SIM ou NÃO e ele dará uma resposta sincera (quer você goste ou não). Fale alto e nitidamente em sua direção.

### POSIÇÃO OFF (DESLIGA)

Isso desliga o MicroNoid. Certifique-se de fazer isso após terminar de brincar com ele para que não descarregue suas baterias.

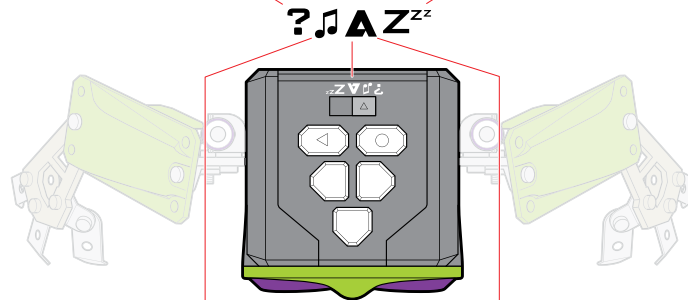

### MODO DE DANÇA

O MicroNoid adora dançar! Toque música perto do MicroNoid e ele dançará conforme o ritmo. Se você deixar ele nesse modo por muito tempo, ele poderá começar a dançar sua própria música.

### MODO AUTÔNOMO

O MicroNoid tem sua própria consciência. Ele pode dar uma risadinha, soltar pum, dançar ou cantar nesse modo. Se houver outro MicroNoid por perto, eles podem começar a interagir ou dançar no mesmo ritmo.

## FUNÇÕES DOS BOTÕES

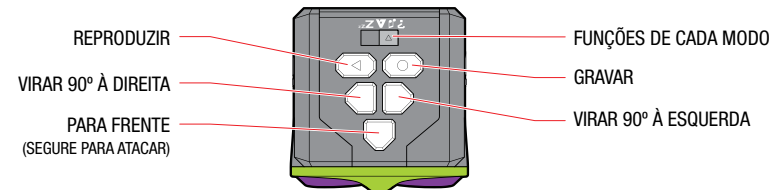

### PRESSIONE O BOTÃO PARA PROGRAMAR

Isso permite que você use os botões de seta para personalizar sua própria sequência de passos e curva. Se você falar com ele nesse modo, ele gravará sua voz e repetirá com sua voz de robô.

#### 1. PRESSIONE GRAVAR

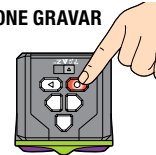

#### 2. PRESSIONE A SEQUÊNCIA DE SETAS

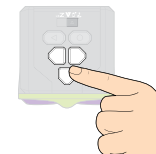

#### 3. PRESSIONE PARA REPRODUZIR

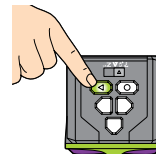

### PROGRAMAÇÃO DE LIM (MOVIMENTO INTELIGENTE APRENDIDO) (LEARNED INTELLIGENT MOTION)

Isso permite que você gire a cabeça para gravar sua própria sequência de passos e curva personalizados. Se você falar com ele nesse modo, ele gravará sua voz e repetirá com sua voz de robô.

#### 1. PRESSIONE GRAVAR

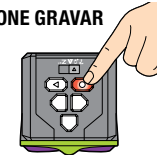

#### 2. GIRE A CABAÇA

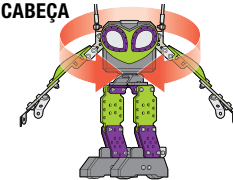

#### 3. PRESSIONE PARA REPRODUZIR

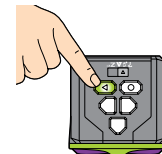

## ОПИСАНИЕ РЕЖИМОВ

### РЕЖИМ ПРЕДСКАЗАНИЙ

В этом режиме MicroNoid будет отвечать на вопросы ДА или НЕТ. Задай вопрос своему MicroNoid, и он честно **ответит** ДА или НЕТ (вне зависимости от того, понравится ли тебе ответ). Говори громко и четко.

### ВЫКЛЮЧЕНИЕ

MicroNoid будет отключен. Чтобы не истощить элементы питания, выключай его каждый раз, когда заканчиваешь играть с ним.

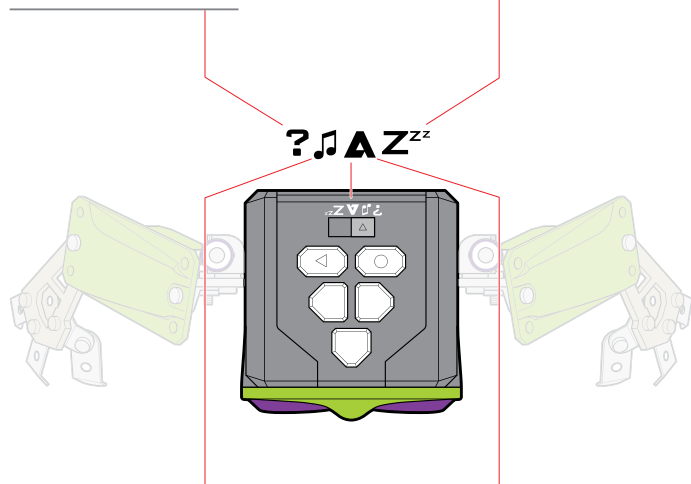

### РЕЖИМ ТАНЦЕВ

MicroNoid любит танцевать! Включи музыку рядом с MicroNoid, и он начнет танцевать. Если он долго находится в этом режиме, он может начать танцевать под собственную мелодию.

### АВТОНОМНЫЙ РЕЖИМ

MicroNoid действует сам. Он может хихикать, пукать, болтать, танцевать и петь в этом режиме. Если поблизости есть другой робот MicroNoid, они могут взаимодействовать друг с другом или синхронно танцевать.

## ДЕЙСТВИЯ КНОПОК

### ВОСПРОИЗВЕДЕНИЕ

ПОВОРОТ  
ВПРАВО НА 90  
ГРАДУСОВ  
ВПЕРЕД  
(УДЕРЖИВАЙ ДЛЯ АТАКИ)

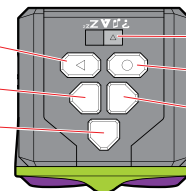

ОПИСАНИЕ РЕЖИМОВ

ЗАПИСЬ

ПОВОРОТ ВЛЕВО НА  
90 ГРАДУСОВ

### ПРОГРАММИРОВАНИЕ КНОПКАМИ

Ты сможешь задать последовательность шагов и поворотов с помощью кнопок со стрелками. Если ты заговоришь с ним в этом режиме, он запишет твой голос и повторит своим голосом робота.

#### 1. НАЖМИ КНОПКУ ЗАПИСИ

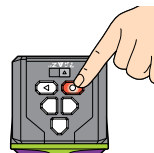

#### 2. ЗАДАЙ ПОСЛЕДОВАТЕЛЬНОСТЬ

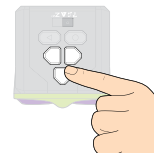

#### 3. НАЖМИ КНОПКУ ВОСПРОИЗВЕДЕНИЯ

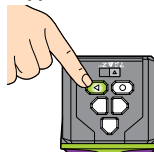

### ПРОГРАММИРОВАНИЕ ДВИЖЕНИЙ

(ИНТЕЛЛЕКТУАЛЬНАЯ СИСТЕМА ПРОГРАММИРОВАНИЯ **ДВИЖЕНИЙ**)

Ты сможешь задать последовательность шагов и поворотов во время того, как робот поворачивает голову. Если ты заговоришь с ним в этом режиме, он запишет твой голос и повторит своим голосом робота.

#### 1. НАЖМИ КНОПКУ ЗАПИСИ

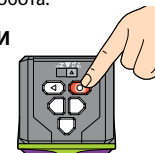

#### 2. ПОВЕРНИ ГОЛОВУ

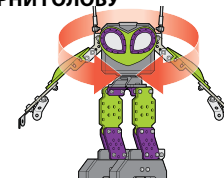

#### 3. НАЖМИ КНОПКУ ВОСПРОИЗВЕДЕНИЯ

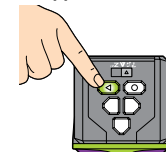





**EN** When this product has reached the end of its useful life it should not be disposed of with other household waste. The Waste Electrical and Electronic Equipment Regulations require it to be separately collected so that it can be treated using the best available recovery and recycling techniques. This will minimize the impact on the environment and human health from soil and water contamination by any hazardous substances, decrease the resources required to make new products and avoid using up landfill space. Please do your part by keeping this product out of the municipal waste stream! The "wheele bin" symbol means that it should be collected as "waste electrical and electronic equipment". You can return an old product to your retailer when you buy a similar new one. For other options, please contact your local council.

**FR** Lorsque ce produit arrive en fin de vie, il ne doit pas être jeté avec le reste des déchets ménagers. Conformément à la directive sur les Déchets des Équipements électriques et électroniques (DEEE), il doit être collecté séparément afin d'être éliminé selon les meilleures techniques de récupération et de recyclage disponibles. Cette démarche réduit les risques de pollution du sol et des eaux, et permet ainsi de minimiser l'impact de toute substance nocive sur la santé et sur l'environnement. Cela diminue également la quantité de ressources nécessaires à la fabrication de nouveaux produits, et évite la saturation des sites d'enfouissement. Veuillez apporter votre contribution en ne jetant pas ce produit avec les déchets de votre commune. Le symbole de la « poubelle sur roues » signifie que ce produit doit faire l'objet d'une collecte respectant la directive sur les Déchets des Équipements électriques et électroniques (DEEE). Vous pouvez également retourner les produits en fin de vie à votre détaillant lors de l'achat d'un produit similaire neuf. Pour plus d'informations, contactez votre commune.

**ES** Cuando este producto alcance el final de su vida útil, no lo deseches como residuo doméstico. La normativa exige que se recoja de forma separada para que pueda tratarse con las mejores técnicas de recuperación y reciclaje disponibles. De esta forma, se minimizará el impacto que la contaminación del suelo y el agua causada por sustancias peligrosas tiene sobre el medio ambiente y la salud humana, se reducirán los recursos necesarios para fabricar nuevos productos y se evitará la saturación de los vertederos. Colabora desechando este producto de forma adecuada! El símbolo del contenedor con ruedas significa que debería recogerse como residuo de aparatos eléctricos y electrónicos. Puedes devolver un producto antiguo en tu establecimiento habitual cuando adquieras un producto nuevo similar. Si deseas obtener más información, consulta con las autoridades locales.

**DE** Ist das Gerät nicht mehr zu gebrauchen, darf es nicht über den Hausmüll entsorgt werden. Die Elektroaltgeräteverordnung (EAG-VO) sieht vor, dass das Gerät separat entsorgt wird, damit es so weit wie möglich recycelt werden kann. Dadurch lassen sich die Menge an umwelt- und gesundheitsschädlichen Substanzen, die über den Boden und das Grundwasser in den menschlichen Nahrungskreislauf gelangen könnten, minimieren, die für die Herstellung neuer Produkte erforderlichen Ressourcen reduzieren und Platz auf Mülldeponien sparen. Leisten Sie Ihren Beitrag dazu, indem Sie das Gerät nicht über den Hausmüll entsorgen. Das Mülltonnen-Symbol bedeutet, dass das Gerät gemäß den Vorschriften für Elektro- und Elektronikgeräte entsorgt werden muss. Alte Geräte können oft beim Kauf eines neuen, ähnlichen Geräts im Einzelhandel zurückgegeben werden. Weitere Entsorgungsmöglichkeiten erfragen Sie bitte bei Ihrer Gemeindeverwaltung.

**NL** Wanneer dit product het einde van zijn levensduur heeft bereikt, mag het niet samen met ander huishoudelijk afval worden weggegooid. Volgens de wet moet het afzonderlijk worden ingezameld zodat het kan worden behandeld met de best beschikbare recycletechnieken. Op deze manier wordt de invloed op het milieu en de menselijke gezondheid van grond- en watervervuiling door gevaarlijke stoffen geminimaliseerd, hoeven er minder bronnen te worden gebruikt om nieuwe producten te maken en raken stortplaatsen minder snel vol. Draag je steentje bij door dit product uit de gemeentelijke afvalstroom te houden! Het afvalcontainersymbool betekent dat het product moet worden ingezameld als elektrische en elektronische afvalapparatuur. Je kunt een oud product inruilen bij de detailhandelaar wanneer je een vergelijkbaar nieuw product koopt. Neem voor andere opties contact op met de gemeente.

**IT** Il simbolo del cassonetto barrato riportato sull'apparecchiatura indica che il prodotto alla fine della propria vita utile deve essere raccolto separatamente dagli altri rifiuti. L'utente dovrà, pertanto, conferire l'apparecchiatura integra dei componenti essenziali giunta a fine vita agli idonei centri di raccolta differenziata di rifiuti elettrici ed elettronici, oppure riconsegnarla al rivenditore al momento dell'acquisto di una nuova apparecchiatura di tipo equivalente, in ragione di uno a uno. L'adeguata raccolta differenziata per l'avvio successivo dell'apparecchiatura dimessa al riciclaggio, al trattamento e allo smaltimento ambientale compatibile contribuisce ad evitare possibili effetti negativi sull'ambiente e sulla salute e favorisce il riciclo dei materiali di cui è composta l'apparecchiatura. Lo smaltimento abusivo del prodotto da parte dell'utente comporta l'applicazione delle sanzioni amministrative di cui al D.Lgs n.152/2006 (parte 4 art.255).

**PT** Quando este produto alcançar o fim da sua vida útil não deverá ser eliminado junto dos resíduos domésticos. Por lei, deverá ser recolhido em separado para posterior tratamento usando as melhores técnicas de recuperação e reciclagem disponíveis. Desta forma, minimiza-se o impacto no ambiente e saúde humana da contaminação do solo e água por substâncias perigosas, diminui-se os recursos necessários para fabricar novos produtos e evita-se o esgotamento do espaço em aterros sanitários. Colabore mantendo este produto fora da rede de recolha de resíduos urbanos! O símbolo de "caixote de lixo móvel" significa que o produto deverá ser recolhido como "resíduo de equipamento eléctrico e electrónico". Pode devolver um produto antigo a loja quando compra outro semelhante. Contacte as autoridades locais relativamente à disponibilidade de outras opções.

**RU** По окончании срока эксплуатации не выбрасывайте игрушку вместе с бытовыми отходами. Согласно закону об утилизации электрических и электронных устройств, необходимо утилизировать отдельным способом, с использованием наиболее продвинутой технологии утилизации и переработки. Это позволит снизить негативные последствия для окружающей среды и здоровья человека, уменьшить загрязнение воды и почвы опасными веществами, а также снизить количество ресурсов, необходимых для изготовления новых игрушек и сократить объем мусора на городских свалках. Внесите свой вклад, сохранив город чистым. Значок с изображением переручной корзины означает, что игрушку следует утилизировать согласно закону об утилизации электрических и электронных устройств. При покупке новой игрушки вы можете вернуть старую в магазин. Чтобы узнать о других возможных вариантах утилизации, обратитесь в местную перерабатывающую организацию.

**EN** Battery Safety Information: Requires **3xAAA**/LR03 1.5V alkaline batteries (not included). Batteries are small objects. Replacement of batteries must be done by adults. Follow the polarity (+/-) diagram in the batteries compartment. Promptly remove dead batteries from the toy. Dispose of used batteries properly. Remove batteries for prolonged storage. Only batteries of the same or equivalent type as recommended are to be used. DO NOT incinerate used batteries. DO NOT dispose of batteries in fire, as batteries may explode or leak. DO NOT mix old and new batteries or types of batteries (i.e. alkaline/standard). DO NOT use rechargeable batteries. DO NOT recharge non-rechargeable batteries. DO NOT short-circuit the supply terminals.

**FR** Informations de sécurité concernant les piles : Fonctionne avec **3 piles alcalines AAA/LR03 1,5 V** (non fournies). Les piles sont des objets de petite taille. Le remplacement des piles doit être effectué par un adulte. Respecter le schéma de polarité (+/-) figurant sur le compartiment des piles. Retirez immédiatement toute pile usagée du jouet. Les piles usagées doivent être jetées conformément aux réglementations en vigueur. Retirez les piles lorsque le produit n'est pas utilisé pendant une période prolongée. Utilisez uniquement des piles identiques ou équivalentes à celles recommandées. NE PAS incinérer les piles usagées. NE PAS jeter au feu des piles usagées, car elles risqueraient d'exploser ou de fuir. NE PAS combiner des piles neuves et usagées, ou des piles de types différents (alcalines et standard, par exemple). NE PAS utiliser de piles rechargeables. NE PAS recharger de piles non-rechargeables. NE PAS court-circuiter les bornes d'alimentation.

**ES** Información de seguridad sobre las pilas: Funciona con **3 pilas alcalinas AAA/LR03 de 1,5 V** (no incluidas). Las pilas son objetos pequeños. Las pilas deben ser sustituidas por un adulto. Siga el esquema de polaridad (+/-) que aparece en el compartimento de las pilas. Retire cuanto antes las pilas gastadas del juguete. Deseche las pilas usadas de manera apropiada. Retire las pilas si se va a guardar el juguete durante un tiempo prolongado. Utilice únicamente pilas del tipo recomendado o de un tipo equivalente. NO incinere las pilas usadas. NO arroje las pilas al fuego, ya que podrían explotar o desprender productos químicos. NO mezcle pilas nuevas con pilas usadas, ni distintos tipos de pilas (p. ej., alcalinas y normales). NO use pilas recargables. NO recargue pilas no recargables. NO cause cortocircuitos en las terminales de corriente.

**DE** Sicherheitshinweise zu Batterien: Benötigt **3x 1,5-V-Alkali-Mikrozellen (AAA/LR03)** (nicht enthalten). Batterien sind kleine Gegenstände. Batterien müssen von Erwachsenen ausgewechselt werden. Das Polaritätsdiagramm (+/-) im Batteriefach beachten. Leere Batterien sofort aus dem Spielzeug entfernen. Verbrauchte Batterien ordnungsgemäß entsorgen. Bei längerfristiger Lagerung Batterien vorher entfernen. Nur dieselben oder gleichwertige Batterien wie empfohlen verwenden. Verbrauchte Batterien NICHT vermischen. Batterien NICHT in Feuer entsorgen, da sie explodieren oder auslaufen könnten. Alte und neue Batterien oder verschiedene Batterietypen (z. B. Alkali/Standard) NICHT zusammen einlegen. KEINE aufladbaren Batterien verwenden. Nicht-aufladbare Batterien NICHT aufladen. Batteriepole NICHT kurzschließen.

**NL** Veiligheidsinformatie met betrekking tot de batterijen: Vereist **3 AAA-alkalinebatterijen van 1,5 V (LR03)** (niet inbegrepen). Batterijen zijn kleine voorwerpen. Het vervangen van batterijen dient door volwassenen te worden gedaan. Hou je aan het polariteitsdiagram (+/-) in het batterijkvak. Verwijder lege batterijen onmiddellijk uit het speelgoed. Zorg voor een milieuvriendelijke afvalverwerking van de batterijen. Verwijder de batterijen als het speelgoed voor langere tijd wordt opgeborgen. Alleen batterijen van het aanbevolen type of een equivalent daarvan mogen worden gebruikt. Slek gebruikte batterijen NOOIT in brand. Gooi batterijen NOOIT in vuur. Hierdoor kunnen deze ontploffen of gaan lekken. Gebruik oude en nieuwe batterijen of verschillende typen batterijen (bijv. alkaline/standaard) NOOIT door elkaar. Gebruik GEEN oplaadbare batterijen. Laad niet-oplaadbare batterijen NOOIT op. Veroorzaak NOOIT kortsluiting tussen de contactpunten.

**IT** Informazioni di sicurezza per le pile: Richiede **3 pile alcaline AAA/LR03 da 1,5 V** (non incluse). Le pile sono oggetti di piccole dimensioni. Le pile devono essere sostituite da adulti. Seguire il diagramma della polarità (+/-) nello scomparto pile. Rimuovere rapidamente le pile scariche dal giocattolo. Smaltire correttamente le pile usate. Rimuovere le pile quando il prodotto non deve essere usato per periodi prolungati. Usare solo pile del tipo consigliato o di tipo equivalente. NON bruciare le pile usate. NON smaltire le pile usate nel fuoco: potrebbero esplodere o lascar tossicanti il contenuto. NON miscelare pile vecchie e nuove o di pile diverse (ad esempio alcaline e standard). NON usare pile ricaricabili. NON ricaricare pile non ricaricabili. NON cortocircuitare i terminali delle pile.

**PT** Informação de segurança das pilhas: Requer **3 pilhas alcalinas AAA/LR03 de 1,5 V** (não incluídas). As pilhas são objetos pequenos. A substituição das pilhas deverá ser feita por um adulto. Deverá seguir-se o indicador da polaridade (+/-) no compartimento das pilhas. As pilhas gastas deverão ser imediatamente retiradas do brinquedo. As pilhas usadas deverão ser correctamente descartadas. Remover as pilhas durante períodos prolongados de armazenamento. Deverão utilizar-se apenas pilhas do mesmo tipo (ou de um tipo equivalente) ou recomendado. NÃO incinerar pilhas usadas. NÃO eliminar pilhas em fogo, pois podem explodir ou vazar. NÃO combinar pilhas usadas e novas ou tipos de pilhas (p. ex.: alcalinas/padrão). NÃO usar pilhas recarregáveis. NÃO recarregar pilhas não recarregáveis. NÃO permita que ocorra curto-circuito nos terminais do produto.

**RU** Информация о технике безопасности при эксплуатации элементов питания: Для работы требуются **3 щелочных элемента питания типа AAA/LR03 1,5 В** (не входят в комплект). Элементы питания представляют собой миниатюрные предметы. Замену элементов питания должны выполнять взрослые. Соблюдайте полярность (+/-), указанную в отсеке элементов питания. Не оставляйте разрядившиеся элементы питания в игрушке. Утилизируйте элементы питания надлежащим образом. Извлекайте элементы питания, если игрушка не используется долгое время. Рекомендуется использовать элементы питания одного или эквивалентного типа. Не сжигайте использованные элементы питания. Не бросайте элементы питания в огонь. Это может привести к их утечке или взрыву. Не используйте новые элементы питания в сочетании с использованными или элементами питания разного типа (т.е. щелочные/обычные). Не используйте перезаряжаемые элементы питания. ЗАПРЕЩАЕТСЯ заряжать неперезаряжаемые элементы питания. ИЗБЕГАЙТЕ короткого замыкания источников питания.

**EN.** Remove all packaging before use. Retain this information, addresses and phone numbers for future reference. Content may vary from pictures. Meccano reserves the right to discontinue the website [www.meccano.com](http://www.meccano.com) at any time. An adult should periodically check this toy to ensure no damage or hazards exist, if so, remove from use. Children should be supervised during play.

**FR.** Retirer tout l'emballage avant utilisation. Conserver les informations, adresses et numéros de téléphone pour consultation ultérieure. Le contenu peut différer des images. Meccano se réserve le droit de supprimer le site Internet [www.meccano.com](http://www.meccano.com) à tout moment. Un adulte doit régulièrement examiner ce jouet afin de s'assurer qu'il ne présente pas de dommage ni de risque. En cas de problème, ne plus l'utiliser. Les enfants doivent être surveillés lorsqu'ils jouent.

**ES.** Retire todo el embalaje antes de utilizar el producto. Conserve toda la información, las direcciones y los números de teléfono para futuras referencias. El contenido del paquete puede no corresponder con las imágenes. Meccano se reserva el derecho a suspender el sitio web [www.meccano.com](http://www.meccano.com) en cualquier momento. Un adulto debe revisar de forma periódica el juguete para asegurarse de que no supone un riesgo o peligro para el niño; si así fuera el caso, interrumpa su uso. Supervise a los niños mientras juegan con el producto.

**DE.** Entfernen Sie vor der Benutzung sämtliche Verpackungsmaterialien. Alle Informationen, Adressen und Telefonnummern bitte für mögliche Rückfragen aufbewahren. Der Packungsinhalt kann von den Bildern abweichen. Meccano behält sich das Recht vor, den Betrieb der Website [www.meccano.com](http://www.meccano.com) jederzeit einzustellen. Ein Erwachsener sollte regelmäßig sicherstellen, dass das Spielzeug keine Gefahr darstellt, und es gegebenenfalls entfernen. Kinder sollten beim Spielen beaufsichtigt werden.

**NL.** Verwijder de verpakking voor gebruik. Bewaar deze informatie, adressen en telefoonnummers voor toekomstig gebruik. Inhoud kan afwijken van illustraties. Meccano behoudt zich het recht voor de website [www.meccano.com](http://www.meccano.com) wanneer gewenst buiten gebruik te stellen. Een volwassene dient dit speelgoed regelmatig te controleren. In geval van schade of gevaar het speelgoed niet meer gebruiken. Houd toezicht als kinderen spelen.

**IT.** Rimuovere l'imballo prima dell'uso. Conservare informazioni, indirizzi e numeri di telefono per riferimento futuro. Il prodotto potrebbe essere differente dalle immagini. Meccano si riserva il diritto di rimuovere il sito [www.meccano.com](http://www.meccano.com) in qualsiasi momento. Il giocattolo deve essere periodicamente controllato da un adulto per prevenire eventuali danni o rischi; in caso di danno, sospendere l'uso. I bambini devono essere sorvegliati durante il gioco.

**PT.** Remova totalmente a embalagem antes de utilizar. Guarde todos os endereços, números de telefone e demais informações para consulta e referência. O conteúdo poderá ser diferente das ilustrações. A Meccano reserva-se o direito de descontinuar o sítio [www.meccano.com](http://www.meccano.com) a qualquer altura. Um adulto deve verificar o brinquedo periodicamente para garantir que não há danos ou riscos. Se houver, é necessário que o brinquedo seja retirado de uso. Crianças devem ser supervisionadas enquanto brincam.

**RU.** Снимите все упаковочные материалы перед использованием. Запишите указанные на упаковке адреса и номера телефонов, чтобы у вас была возможность связаться с нами. Содержимое упаковки может отличаться от иллюстрации. Компания Meccano оставляет за собой право прекратить использование сайта [www.meccano.com](http://www.meccano.com) в любое время. Взрослым следует время от времени проверять игру и следить за тем, чтобы она не была сломана и не представляла опасности для ребенка. В противном случае ее не следует использовать. Во время игры дети должны находиться под присмотром взрослых.

- ⚠ Warning: CHOKING HAZARD – Small parts.
- ⚠ Attention ! RISQUE D'ÉTOUFFEMENT – Contient de petits éléments.
- ⚠ Advertencia: PELIGRO DE ASFIXIA – Contiene piezas pequeñas. No conveniente para niños menores de 3 años.
- ⚠ Achtung: ERSTICKUNGSGEFAHR – Kleinteile.
- ⚠ Waarschuwing: VERSTIKKINGSGEVAAR – Kleine onderdelen.
- ⚠ Attenzione: RISCHIO DI SOFFOCAMENTO – Pezzi piccoli.
- ⚠ Aviso: PERIGO DE ASFIXIA – Peças pequenas.
- ⚠ Осторожно! ОПАСНОСТЬ УДУШЬЯ – Мелкие детали.



**NORTH AMERICA/AMÉRIQUE DU NORD**

☎ 1-800-622-8339, [customercare@spinmaster.com](mailto:customercare@spinmaster.com)

UK – 0800 206 1191, [serviceuk@spinmaster.com](mailto:serviceuk@spinmaster.com)

IRELAND ☎ 1800 992 249

FRANCE – 0800 909 150, [servicefr@spinmaster.com](mailto:servicefr@spinmaster.com)

DEUTSCHLAND – 0800 0101 0222, [Kundenservice@spinmaster.com](mailto:Kundenservice@spinmaster.com)

SCHWEIZ – 0800 561 350 • ÖSTERREICH – 0800 297 247

NEDERLAND – 0800 022 3683, [klantenservice@spinmaster.com](mailto:klantenservice@spinmaster.com)

BELGIË/BELGIQUE – 0800 77 688 • LUXEMBOURG – 800 2 8044

ITALIA – 800 788 532, [servizio@spinmaster.com](mailto:servizio@spinmaster.com)

MEXICO – 55 4160 7947, [servicio@spinmaster.com](mailto:servicio@spinmaster.com)

[WWW.SPINMASTER.COM](http://WWW.SPINMASTER.COM)



SPIN MASTER LTD., 450 FRONT STREET WEST, TORONTO, ON M5V 1B6 CANADA.

IMPORTED INTO EU BY SPIN MASTER INTERNATIONAL, S.A.R.L.,  
16 AVENUE PASTEUR, L-2310, Luxembourg. [www.spinmaster.com](http://www.spinmaster.com)  
Made in China / Fabriqué en Chine / Hecho en China



TM & © 2016 MECCANO for packaging, instructions and models built with this set. / TM & © 2016 MECCANO pour l'emballage, les notices et modèles de ce coffret. / MECCANO® is an exclusive trademark of MECCANO. Spin Master logo is a trademark of Spin Master Ltd. / MECCANO® est une marque de commerce exclusive de MECCANO. Le logo de Spin Master est une marque de commerce de Spin Master Ltd. / All rights reserved. / Tous droits réservés.

T91815\_0001\_20071983\_GML\_IB\_R1\_MEC\_MicroNoid\_Socket\_CN\_F16

**REVIEWED**

By Katy Davis ([katyd@spinmaster.com](mailto:katyd@spinmaster.com)) at 3:40 pm, Apr 29, 2016

